

**DAISY CRESENT
PRISMATIC**

divinity lights

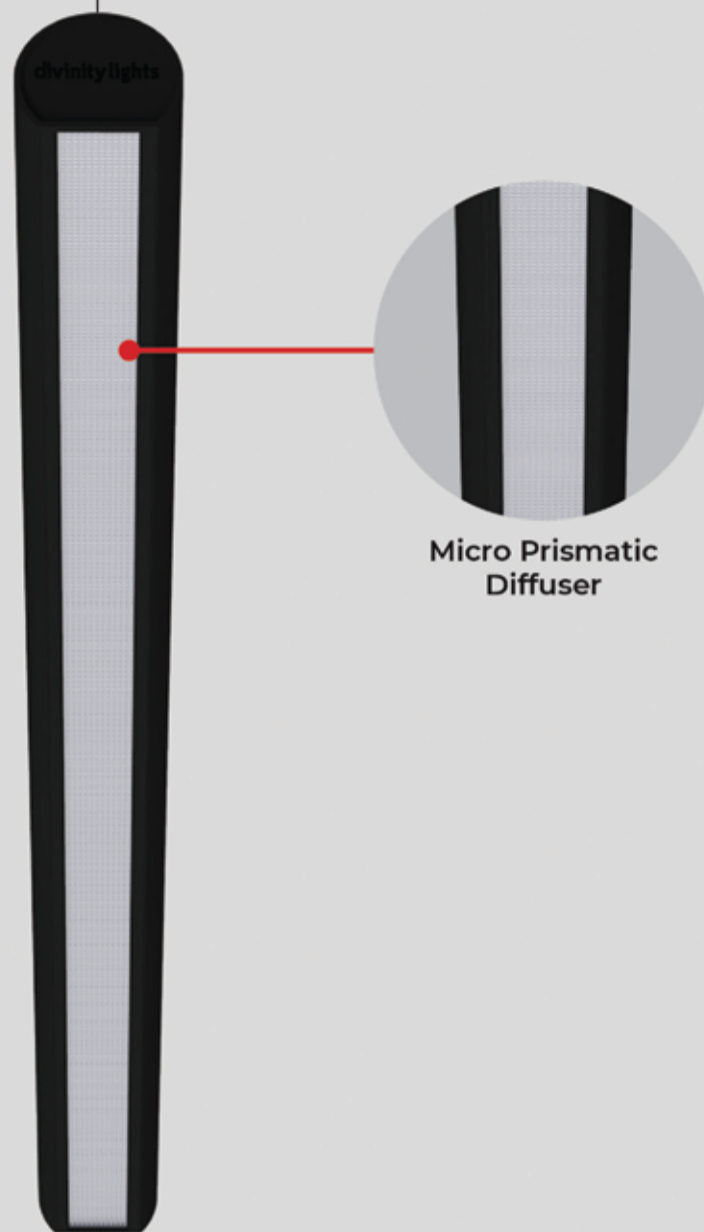



Micro Prismatic Diffuser

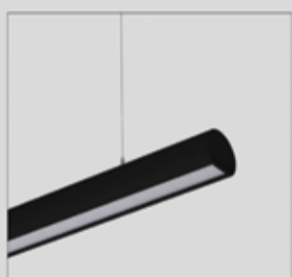

DAISY CRESENT PRISMATIC

Daisy Cresent Prismatic sleek linear fixture has:

- Extruded Aluminium Luminaire Housing
- Premium Finish Powder coating
- High efficiency Prismatic double diffuser
- Better refractive index to reduce glare
- Energy efficient LED with high colour rendering
- LED PCB mounted on insert design with heat sink
- Snap fit system
- No visible screw
- Pendant using suspension cable with M6 bolt and fastener
- Bottom opening for easy maintenance

Quick Info

CRI ≥ 90
 3000K/ 4000K/ 5700K
 Tunable White 2700-6500K
 ON-OFF/ ON-OFF (FLICKER FREE)
 DALI-2 DT6 / DALI-2 DT8/ DALI+
 SDCM<3
 Micro Prismatic Diffuser
 L70 @50,000h
 Aluminium

Types

Pendant/ Surface

Single Line Diagram

Pendant Mounted

Outer Profile Code
 SY-2001

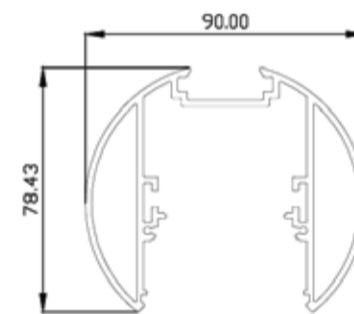

Profile Insert Code
 SY-102

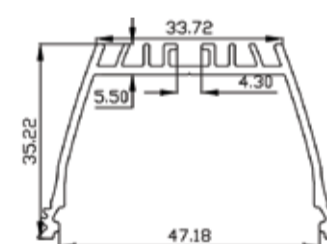

Light Distribution

Direct

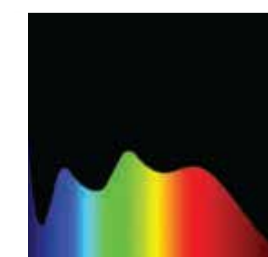

CRI ≥ 90



TUNABLE
 WHITE

DAISY CRESENT PRISMATIC



DAISY CRESENT PRISMATIC

System Power	Dimensions
7W	L = 300mm
14W	L = 600mm
21W	L = 900mm
28W	L = 1200mm
56W	L = 2400mm

Order Options

Distribution

Direct

CCT (Color Temperature)

3000K
4000K
5700K
Tunable 2700K-6500K



CRI

>90

Beam Angle

110°

Control

- ON-OFF
- ON-OFF (FLICKER FREE)
- DALI-2 DT6
- DALI-2 DT8
- DALI +



Mounting Type

- Pendent
- Surface
- Recessed

Material Color

RAL As Per Request

Photometric

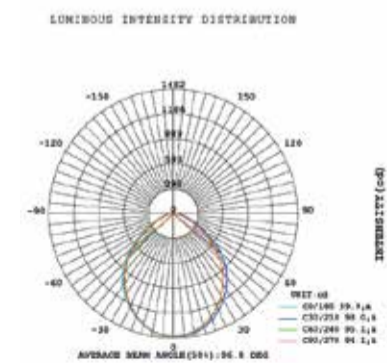

PHOTOMETRIC DEATILS

DAISY-28X1-W

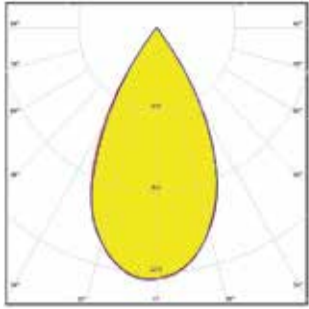

~50° wide beam. Variant with 4X1 lenses.

DAISY-28X1-WW-B

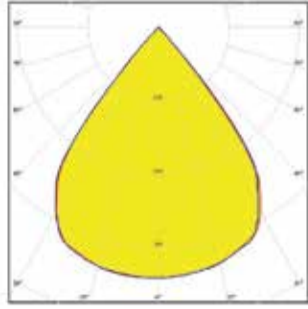

~80° wide beam. Variant with 7X1 lenses.

DAISY-28X1-WW-B-D

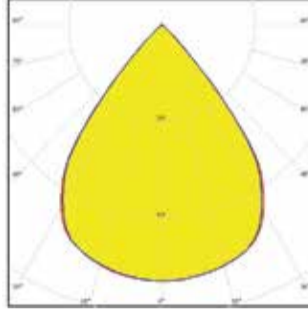

~80° wide beam. Variant with diffused 7X1 lenses.

DAISY-28X1-WW

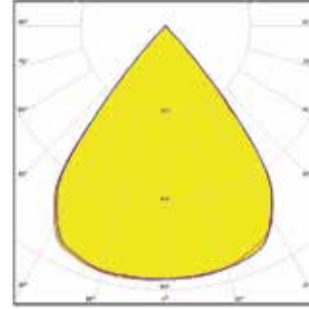

~80° wide beam. Variant with 4X1 lenses.

DAISY-28X1-W-D

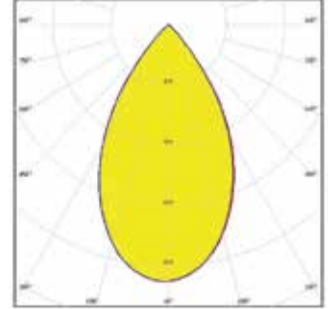

~50° wide beam. Variant with diffused 4X1 lenses.

DAISY-28X1-W2-B

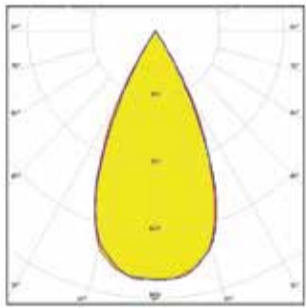

~50° wide beam with tighter cutoff. Variant with 7X1 lenses.

DAISY-28X1-W2-B-D

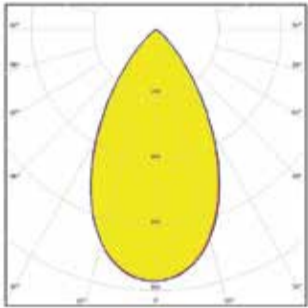

~50° wide beam with tighter cutoff. Variant with diffused 7X1 lenses.

DAISY-28X1-WW-D

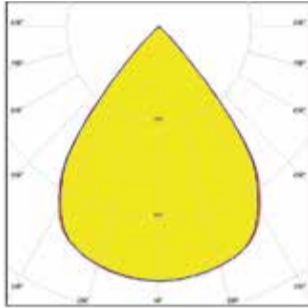

~80° wide beam. Variant with diffused 4X1 lenses.

DAISY-28X1-W-B

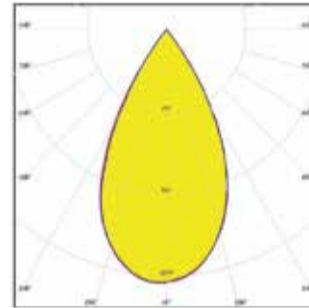

~50° wide beam. Variant with 7X1 lenses.

DAISY-28X1-W-B-D

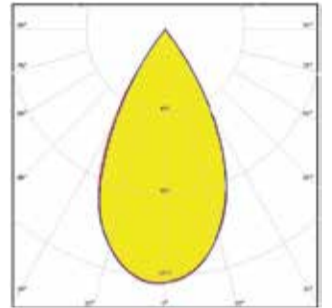

~50° wide beam. Variant with diffused 7X1 lenses.